

RECOMMENDATION OF
DR. ALECSANDRU IONESCU

DR. ALECSANDRU IONESCU

Dr. Alecsandru Ionescu graduated the Faculty of Dentistry within UMF “Carol Davila” Bucharest in 2001. He is a member of the board of the Society for Esthetic Dentistry in Romania (SSER) as Events Director since 2004 and a member of the scientific board of Cosmetic Dentistry Romania since 2007. He is also the co-founder of Quintessence International Romania and a founding member of the Romanian Society for Digital Dentistry. Dr. Ionescu is an active member of the IADFE (International Academy for Dental-Facial Esthetics), ESCD (European Society of Esthetic Dentistry), EAO (European Association for Osseointegration) and ICOI (International Congress of Oral Implantology).

Dr. Ionescu is a specialist in minimally invasive surgical and non-surgical approaches I implantology, periodontology and regenerative dentistry.

He is udergoing a PhD research with the theme: “Guided tissue healing using the open healing concept and flapless techniques”. He is involved in multiple studies and researches related to the minimally invasive oral surgery and implantology, periodontology and regenerative dentistry.

Dr. Ionescu’s main lecturing topics are focused on minimally invasive approaches in oral surgery and implantology. He is a trainer for the “open healing” protocol and minimally invasive techniques using soft tissue level implants. He is also a trainer for piezosurgery. He is an international speaker, author of different articles in the field of aesthetic dentistry and oral implantology and a co-author of the “Comprehensive Esthetic Dentistry”, the first volume by Romanian authors published by Quintessence International in 2015, translated into Chinese in 2017.

Dr. Ionescu develops his professional activity in Bucharest in his private dental clinic, research and training center “aesthetics ONE”.

CONTACT

Aesthetics ONE by dr. Alecsandru IONESCU

t: +40 727 000 700 e: alecs@drionescu.ro w: www.drionescu.ro

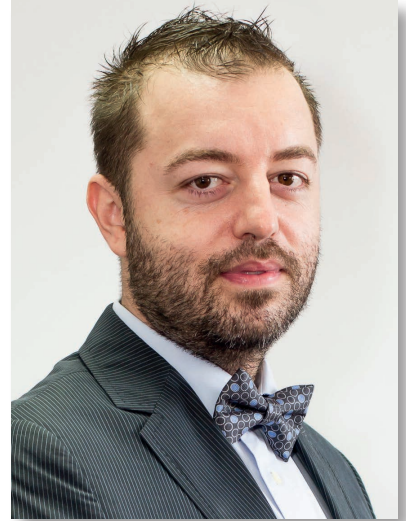

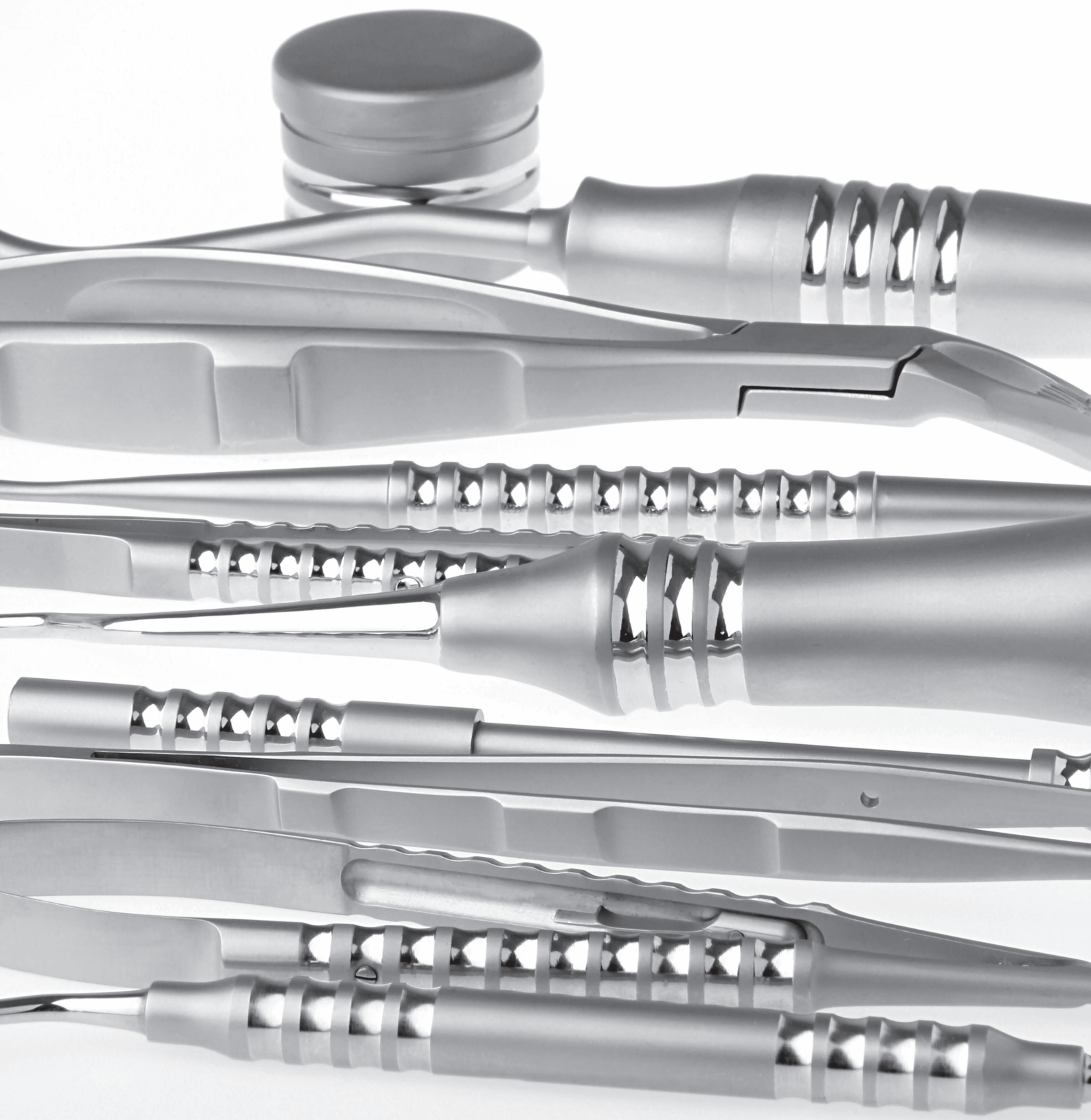







MINIMAL INVASIVE SURGERY SET nach Dr. Alecsandru Ionescu

MINIMAL INVASIVE SURGERY SET in accordance to Dr. Alecsandru Ionescu

MINIMAL INVASIVE SURGERY SET selon Dr. Alecsandru Ionescu



Artikel-Nr. Item no. Articles-Réf.	Bezeichnung Description Description	
888-98 F	 Raspatorium # A2 Periosteal elevator # A2 Rugine, décolleurs # A2	173 mm
888-P3S F	 Raspatorium „Prichard # 3S“ Periosteal elevator „Prichard # 3S“ Rugine, décolleurs „Prichard # 3S“	173 mm
2500-81 F	 Membran Platzierungsinstrument „Buser“ Membrane positioning instrument „Buser“ Instrument pour placement des membranes „Buser“	2,0 / 2,0 mm, 173 mm
2302-66 F	 Atraumatische Mikro-Pinzette „Cooley“ Atraumatic tweezer, micro „Cooley“ Pince atraum. à dissection, micro „Cooley“	173 mm, 0,6 mm, gerade, gerieft 173 mm, 0,6 mm, straight, serrated 173 mm, 0,6 mm, droits, striée
2315-70 F	 Naht- und Membranpinzetten „TEAM-ATLANTA“ Suture and membrane forceps „TEAM-ATLANTA“ Pincettes à suture et à membrane „TEAM-ATLANTA“	173 mm, Ø 1,6 mm
920-00 F	 Knochenküretten „Lucas # OR-OL“ Bone curettes „Lucas # OR-OL“ Curettes à os „Lucas # OR-OL“	173 mm, 1,8/1,8 mm
901-28 F	 Knochenküretten „Miller-Colburn # 13“ Bone curettes „Miller-Colburn # 13“ Curettes à os „Miller-Colburn # 13“	173 mm, 3,0/2,0 mm

Artikel-Nr. Item no. Articles-Réf.	Bezeichnung Description Description	
1086-10 F 	Mikro Nadelhalter „Barraquer“ Micro needle holder „Barraquer“ Micro porte-aiguilles „Barraquer“	173 mm, 1,2 mm, gerade, mit Kreuzriefung 173 mm, 1,2 mm, straight, with cross serration 173 mm, 1,2 mm, droit, striure en forme de croix
2500-34 F 	Stopfer Compactor Compacteur	173 mm
2406-91 F 	Tiefenmeßgerät „Mazor“ # 7 Depth gauge „Mazor“ # 7 Jauge de profondeur „Mazor“ # 7	1,5 mm / 3,0 mm, graduert 1,5 mm / 3,0 mm, graduated 1,5 mm / 3,0 mm, graduée
2406-41	Messzirkel Caliper Compas de mesure	90 mm, 0,0 - 15,0 mm
2385-00 F 	Mundspiegelgriff, M2,5 Mouth mirror handle, M 2,5 Manche de miroir, M 2,5	132 mm
2377-4	MEGA Spiegel MEGA-mirror MEGA-miroir à bouche	Ø 22 mm
2525-40 F 	Parodontometer „CP15 North Carolina“ Periodontal Probes „CP15 North Carolina“ Sondes parodontales „CP15 North Carolina“	156 mm, graduert 156 mm, graduated 156 mm, gradué
1151-30 F 	Skalpellgriff # 3 Scalpel handle # 3 Manche p. bistouri # 3	gerade, passend für 1 Klinge straight, suitable for 1 blade droit, pour 1 lame
1155-1	Chirurgische Schere Surgical scissors Ciseaux chirurgicaux	gerade straight droits
2302-76 F 	Anatomische Mikro-Pinzette Anatomical micro-forceps Micro-Pince anatomique	173 mm, diamantiert, 0,6 mm, gerade 173 mm, diamond coated, 0,6 mm, straight 173 mm, couche de diamant, 0,6 mm, droits
2550-60	Mischdose für Knochenmaterial Mixing bowl for bone material Cuvette de mélange pour mat. osseux	25 cc
9200-10 	GPM Wash Tray (275 x 180 x 35 mm)	mit Deckel mit Haltegriff with cover with handle avec couvercle avec poignée

MINIMAL INVASIVE SURGERY SET nach Dr. Alecsandru Ionescu

MINIMAL INVASIVE SURGERY SET in accordance to Dr. Alecsandru Ionescu

MINIMAL INVASIVE SURGERY SET selon Dr. Alecsandru Ionescu

Raspatorien

Periosteal elevators
Rugines, décolleurs

F-line SL

888-98 F **F-line**
A2 173 mm

scharf | stumpf
sharp | blunt
tranchant, émoussé

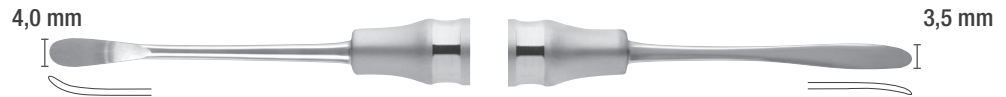

888-P3S F **F-line**
Prichard # 3S 173 mm

gerade
straight
droit

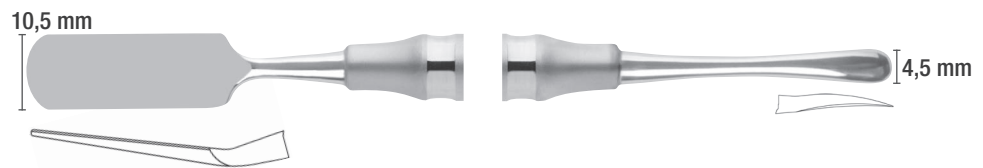

Knochenapplikation

Bone application
Instruments et applicateurs pour l'augmentation

F-line SL

2500-81 F **F-line**
Buser 173 mm

Membran Platzierungsinstrument
Membrane positioning instrument
Instrument pour placement des membranes



Mikro-Pinzetten

Surgical forceps
Pincettes chirurgicales

F-line RS



Atraumatische Mikro-Pinzetten sind ein Kompromiss zwischen den stark fixierenden, jedoch gewebschädigenden chirurgischen Pinzetten und den weniger gut, jedoch schonend fassenden anatomischen Pinzetten. Die feine Mikroverzahnung verhindert eine Perforation sowie schon bei geringem Druck ein Abgleiten des Gewebes und ermöglicht somit ein schonenderes Fassen.



Atraumatic micro-forceps offer a compromise between the surgical forceps, which provide a strong grip yet damage tissue, and the less effective anatomical forceps, which however allow a gentle grip. The fine micro teeth prevent perforation and slippage of the tissue even at very slight pressure, thus enabling gentler gripping.



Une **Micro-Pince atraumatique** est un compromis entre la pince chirurgicale avec une fixation forte, mais avec le risque d'endommager les tissus, et la pince atraumatique avec fixation légère, mais en ménageant les tissus. La denture micro (très fine) empêche, par une légère pression de la pince, une perforation et un glissement des tissus. Cela permet la tenue en douceur.

2302-66 F **F-line**
Cooley 0,6 mm 173 mm

Atraumatische Mikro-Pinzette
Atraumatic micro-forceps
Micro-Pince atraumatique

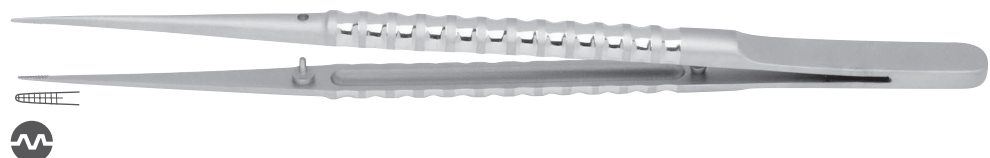

Naht- und Membranpinzetten

Suture and membrane forceps
Pincettes à suture et à membrane

F-line RS



Eine Nahtpinzette ermöglicht eine optimale Einführung von Regenerationsmembranen, gleichzeitig wird ein Vernähen der Gingiva gewährleistet.

Beim Festhalten des Lappens kann die Nadel präzise durch die Öffnung geführt werden. Durch die Präzisionsarbeit kann ein Ausreißen weitestgehend verhindert werden.



These suture forceps allows an optimal insertion of regeneration membrane as the gingiva can be sutured simultaneously.

While the lobe is being held, the needle can be exactly guided through the aperture. This precision work largely prevents any tearing.



Cette pince à œillet s'emploie particulièrement pour la suture des lambeaux fins.

Les lambeaux sont maintenus entre les mors, l'œillet servant de guide à l'aiguille. De cette manière la suture peut s'effectuer précisément ce qui empêche une déchirure.

2315-70 F **F-line**
TEAM-ATLANTA 171 mm

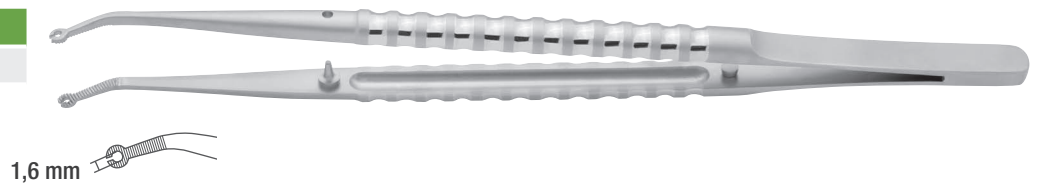

Knochenküretten

Bone curettes
Curettes chirurgicales

920-00 F **F-line**
Lucas # OR-OL 173 mm

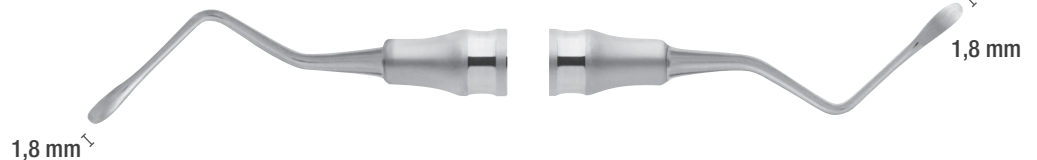

901-28 F **F-line**
Miller-Colburn # 13 173 mm



Mikro-Nadelhalter mit Sperre für minimalinvasive Chirurgie

Micro needle holders with lock for minimally invasive surgery
Porte-aiguilles pour la chirurgie invasive minimisée avec verrouillage

F-line RS

1086-10 F **F-line**
Barraquer 173 mm
1,2 mm

gerade, mit Kreuzriefung
straight, with cross serration
droit, striure en forme de croix

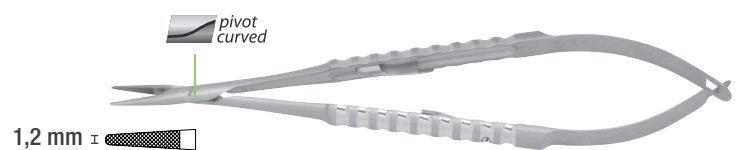

Empfohlen für Fadenstärke:
Recommended for thread size:
Recommandé pour fil à suture:

5-0 – 6-0

MINIMAL INVASIVE SURGERY SET nach Dr. Alecsandru Ionescu

MINIMAL INVASIVE SURGERY SET in accordance to Dr. Alecsandru Ionescu

MINIMAL INVASIVE SURGERY SET selon Dr. Alecsandru Ionescu

Stopfer

Compactor
Compacteur

F-line SL

2500-34 F

F-line

173 mm



Tiefenmessgeräte

Depth gauges
Jauge de profondeur

F-line SL



Die Tiefenmesser ermöglichen eine genaue Messung der Implantatkavität.

Es können die anatomischen Nachbarstrukturen sowie die Integrität der Kavität optimal geprüft werden. Auch das vertikale und horizontale Knochenangebot des Patienten kann mit diesen Instrumenten intraoperativ exakt gemessen werden.



These depth gauges allow to accurately measure the depth of the implant cavity.

The neighbouring anatomical structures and the integrity of the cavity can optimally be checked. The horizontal and vertical bone volume can also be precisely measured intraoperatively.



Ces instrument permet de mesurer avec précision la profondeur de la cavité.

La jauge permet de sonder l'intégrité de la cavité et des structures adjacentes anatomiques. Même pendant l'intervention la sonde peut mesurer avec exactitude la présence osseuse à l'horizontal et à la verticale.

2406-91 F

F-line

Mazor # 7

173 mm

8-10-13-15

graduiert, nicht kalibriert
graduated, non-calibrated
gradué, non calibré



Messzirkel

Caliper
Compas de mesure

2406-10

F-line

Barraquer

90 mm
0,0 - 15,0 mm

gerade, nicht kalibriert
straight, non-calibrated
droit, non calibré

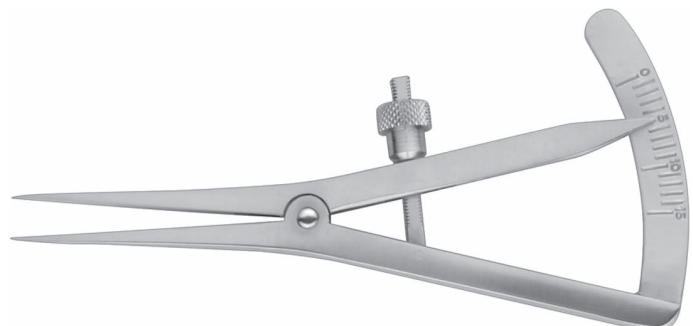



Mundspiegelgriff

Mouth mirror handle
Manche à miroirs

F-line SL

2385-00 F

F-line

M 2,5

132 mm



Mundspiegel – MEGA und MEGAduo – Rhodium Front beschichtet

Mouth mirrors – MEGA and MEGAduo – Front side rhodium plated
Miroirs à bouche – MEGA et MEGAduo – Devant revêtu de rhodium



MEGA und MEGAduo

- Scharfes, verzerrungsfreies und kontrastreiches Bild bis ins kleinste Detail
- Höchster Sehkomfort: ermüdungsfrei und augenschonend in allen Einsatzbereichen
- Einfache Reinigung durch Rhodium mit Anti-Hafteffekt
- Angenehmes Abhalten der Wange durch den breit geformten Stiel



MEGA and MEGAduo

- Pin-sharp accuracy, distortion-free and a high-contrast image
- Utmost degree of optic convenience – fatigue-proof and eyefriendly in all fields of application
- Easy cleaning due to Rhodium with non-adhesive effect
- Comfortable holding back of the cheek because of the wide-shaped handle



MEGA et MEGAduo

- Vision exacte et très nette jusque dans les plus petits détails
- Confort visuel et sans fatigue pour les yeux
- Nettoyage facile grâce à une couche de rhodium
- Rétraction plus confortable grâce à une tige large



Artikel-Nr. Item no. Article-Réf.			Ø mm	Größe Size Taille	Packung Package Paquet
2377-4	MEGA Spiegel MEGA-mirror MEGA-miroir à bouche	plan plane plan	22	4	12



Die MEGAduo-Spiegel haben ein doppelseitiges Spiegelglas
MEGAduo-mirrors have a double-sided mirror glass.
Les miroirs à bouche MEGAduo ont un verre recto-verso.

MINIMAL INVASIVE SURGERY SET nach Dr. Alecsandru Ionescu

MINIMAL INVASIVE SURGERY SET in accordance to Dr. Alecsandru Ionescu

MINIMAL INVASIVE SURGERY SET selon Dr. Alecsandru Ionescu

Parodontometer | einendig

Periodontal Probes | single ended

Sondes parodontales | simples

F-line SL

2525-40 F **F-line**

CP15 North Carolina 156 mm

1-2-3-...-14-15

graduiert, nicht kalibriert
graduated, non-calibrated
gradu , non calibr 

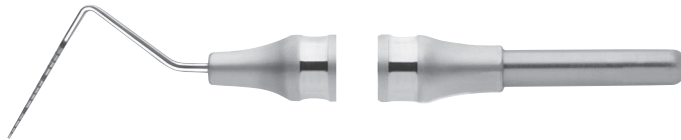

Skalpellingengerhalter | einendig

Scalpel blade holders | single-ended

Manches de bistouris | simples

F-line SL

1151-30 F **F-line**

3 158 mm

gerade, passend f r 1 Klinge
straight, suitable for 1 blade
droit, pour 1 lame

Der runde Skalpellgriff dient f r eine exakt zirkul re Schnitff hrung.
Our round scalpel blade holder is perfect for precise circular incisions.
Le manche arrondi permet une incision circulaire pr cise.



Chirurgische Scheren

Surgical scissors

Ciseaux chirurgicaux

1155-1 **RC**

Iris 115 mm

gerade
straight
droits

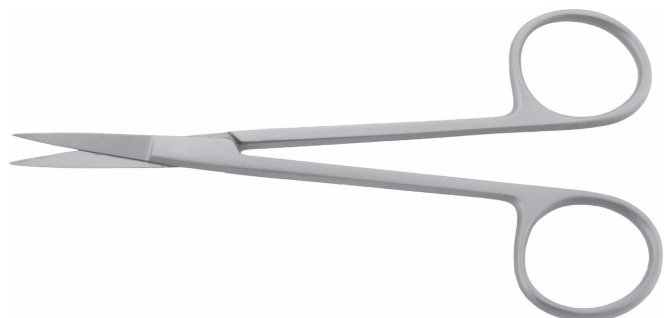



Mikro-Pinzetten

Surgical forceps
Pincès chirurgicales

F-line RS

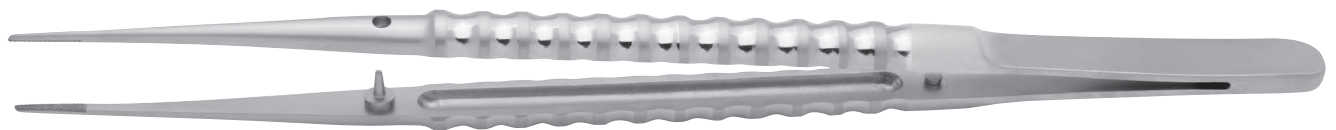

2302-76 F

F-line

TC

0,6 mm
173 mm

Anatomische Mikro-Pinzette
Anatomical micro forceps
Micro-Pince anatomique

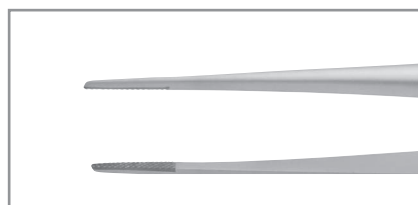

Mischdosen für Knochenmaterial

Mixing bowls for bone material
Cuvette de mélange pour matériau osseux

2550-60

28 mm
Ø 60 mm
25 cc





devemed GmbH

take-off GewerbePark 30
78579 Neuhausen ob Eck
GERMANY 

Tel: +49 (0) 74 67 - 94 91 99-0

Fax: +49 (0) 74 67 - 94 91 99-19

info@devemed.de
www.devemed.de



03/23